

Tagli di luce

Profili Architeturali

Schermo
arretrato per
UGR controllato



Trimless

Bridge

Design
registrato

Leggero
435g/m

Versatile

Qualità dei
materiali

Facilità di
trasporto e
installazione

Facilità di
smaltimento



BRIDGE LINEARE / LINEAR BRIDGE BG01

435g/m

105 x L+5 mm



Controcassa in polistirene e PVC da 1000mm, per installazione a incasso in cartongesso continuo di spessore 12,5mm. Il codice prodotto include: 2 pcs da 1000mm di struttura, 2pcs da 1000mm di profilo in alluminio per striscia LED con diffusore in PC opale e 2pcs da 1000mm di guaina in neoprene a protezione del profilo in alluminio durante la rasatura. Fissaggio alla struttura del cartongesso esistente tramite viti (non incluse). Disponibile versione con taglio a 45° sull'estremità per la realizzazione di angoli a 90°.

Linear structure in polystyrene and PVC for recessed installation in plasterboard 12,5mm depth. The product code includes: 2 pcs of 1000mm of structure, 2 pcs of 1000mm of aluminum profile for LED strip with opal PC diffuser and 2 pcs of 1000mm of neoprene sheath to protect the 3M adhesive provided for gluing the aluminum profile after plastering. Fixing to the existing plasterboard structure using screws (not included). Available version with 45° cut on one side to realise 90° corner.

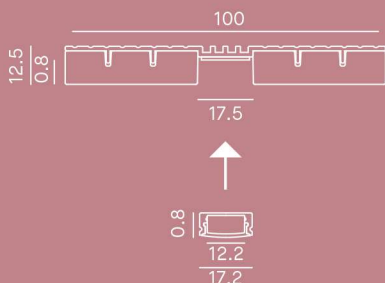

Profilo con taglio lineare - Linear profile

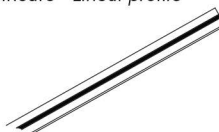

Profilo con taglio a 45° - Corner profile



Code	Diffuser	PC
BG/01/S	opale - opal	PC

Code	Diffuser	PC
BG/01/LA/S	opale - opal	PC

Accessori disponibili su richiesta - Accessories available upon request

Code	Descrizione	Description
DIF.B/STRIP/3E/S	Diffusore opale L.2m	Opal diffuser L.2m
DIFF/10M/S	Diffusore opale in bobina L.10m	Opal diffuser roll L.10m
DIFF/5M/S	Diffusore opale in bobina L.5m	Opal diffuser roll L.5m

BRIDGE LINEARE / LINEAR BRIDGE BG02

455g/m

111.5 x L+5 mm



Controcassa in polistirene e PVC da 1000mm, per installazione a incasso in cartongesso continuo di spessore 12,5mm. Il codice prodotto include: 2 pcs da 1000mm di struttura, 2pcs da 1000mm di profilo in alluminio per striscia LED con diffusore in PC opale e 2pcs da 1000mm di guaina in neoprene a protezione del profilo in alluminio durante la rasatura. Fissaggio alla struttura del cartongesso esistente tramite viti (non incluse). Disponibile versione con taglio a 45° sull'estremità per la realizzazione di angoli a 90°.

Linear structure in polystyrene and PVC for recessed installation in plasterboard 12,5mm depth. The product code includes: 2 pcs of 1000mm of structure, 2 pcs of 1000mm of aluminum profile for LED strip with opal PC diffuser and 2 pcs of 1000mm of neoprene sheath to protect the 3M adhesive provided for gluing the aluminum profile after plastering. Fixing to the existing plasterboard structure using screws (not included). Available version with 45° cut on one side to realise 90° corner.

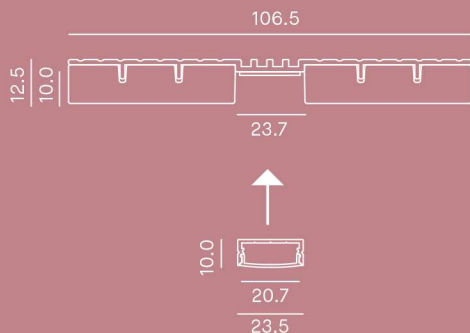

Profilo con taglio lineare - Linear profile



Profilo con taglio a 45° - Corner profile



Code	Diffuser	PC
BG/02/S	opale - opal	PC

Code	Diffuser	PC
BG/02/LA/S	opale - opal	PC

Accessori disponibili su richiesta - Accessories available upon request

Code	Descrizione	Description
DIFF.B/STRIP/9/S	Diffusore opale L.2m	Opal diffuser L.2m
DIFF/10M/9S	Diffusore opale in bobina L.10m	Opal diffuser roll L.10m

BRIDGE ANGOLARE / ANGLED BRIDGE BG01 IN

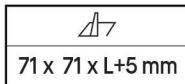

570g/m

Controcassa in polistirene e PVC da 1000mm, per installazione a incasso in cartongesso di spessore 12,5mm. Ideale per la realizzazione di tagli di luce verticali e/o orizzontali ad angolo interno su cartongesso. Il codice prodotto include: 2 pcs da 1000mm di struttura, 2pcs da 1000mm di profilo in alluminio per striscia LED con diffusore in PC opale e 2pcs da 1000mm di guaina in neoprene a protezione del profilo in alluminio durante la rasatura. Fissaggio alla struttura del cartongesso esistente tramite viti (non incluse).

Linear structure in polystyrene and PVC for recessed installation in plasterboard 12,5mm depth, length 1000mm. Ideal for the realisation of vertical or horizontal lines of light with internal corner on plasterboard. The product code includes: 2 pcs of 1000mm of structure, 2 pcs of 1000mm of aluminum profile for LED strip with opal PC diffuser and 2 pcs of 1000mm of neoprene sheath to protect the 3M adhesive provided for gluing the aluminum profile after plastering. Fixing to the existing plasterboard structure using screws (not included).



Profilo lineare - Linear profile

Code	Diffusore	
BG/01/IN/S	opale - opal	PC

Accessori disponibili su richiesta - Accessories available upon request

Code	Descrizione	Description
DIF.B/STRIP/3E/S	Diffusore opale L.2m	Opal diffuser L.2m
DIFF/10M/S	Diffusore opale in bobina L.10m	Opal diffuser roll L.10m
DIFF/5M/S	Diffusore opale in bobina L.5m	Opal diffuser roll L.5m

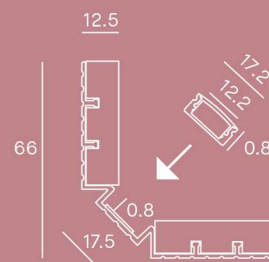
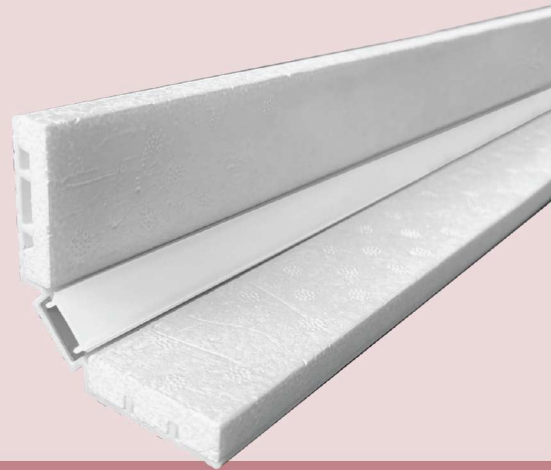

BRIDGE ANGOLARE / ANGLED BRIDGE BG01 OUT

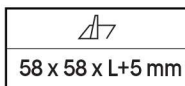

670g/m

Controcassa in polistirene e PVC da 1000mm, per installazione a incasso in cartongesso di spessore 12,5mm. Ideale per la realizzazione di tagli di luce verticali e/o orizzontali ad angolo esterno su cartongesso. Il codice prodotto include: 2 pcs da 1000mm di struttura, 2pcs da 1000mm di profilo in alluminio per striscia LED con diffusore in PC opale e 2pcs da 1000mm di guaina in neoprene a protezione del profilo in alluminio durante la rasatura. Fissaggio alla struttura del cartongesso esistente tramite viti (non incluse).

Linear structure in polystyrene and PVC for recessed installation in plasterboard 12,5mm depth, length 1000mm. Ideal for the realisation of vertical or horizontal lines of light with external corner on plasterboard. The product code includes: 2 pcs of 1000mm of structure, 2 pcs of 1000mm of aluminum profile for LED strip with opal PC diffuser and 2 pcs of 1000mm of neoprene sheath to protect the 3M adhesive provided for gluing the aluminum profile after plastering. Fixing to the existing plasterboard structure using screws (not included).



Profilo lineare - Linear profile

Code	Diffusore	
BG/01/OUT/S	opale - opal	PC

Accessori disponibili su richiesta - Accessories available upon request

Code	Descrizione	Description
DIF.B/STRIP/3E/S	Diffusore opale L.2m	Opal diffuser L.2m
DIFF/10M/S	Diffusore opale in bobina L.10m	Opal diffuser roll L.10m
DIFF/5M/S	Diffusore opale in bobina L.5m	Opal diffuser roll L.5m

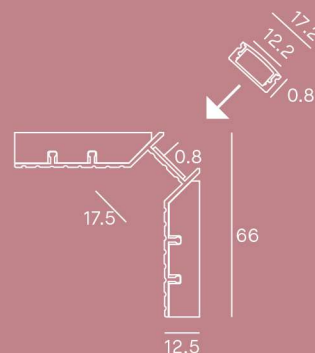

PROFILO TRIMLESS / TRIMLESS PROFILE PA09



28.5 x L+5 mm

Profilo in alluminio lineare per striscia LED, lunghezza 2000mm. Installazione da incasso trimless in controsoffitti di cartongesso da 12,5mm. Alluminio anodizzato. Installazione con alette laterali tramite viti. Diffusore opale in PC.

Linear aluminium profile for LED strip, length 2000mm. Trimless recessed-mounted installation on plasterboard ceiling of 12,5mm. Anodized aluminium. Installation through lateral edges with screws. Opal PC diffuser

Code	Diffuser		Code (1cm)	
PA/09/S	opale - opal	PC	PA/09/S/1	Taglio su misura - Customized length

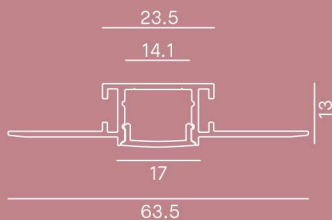
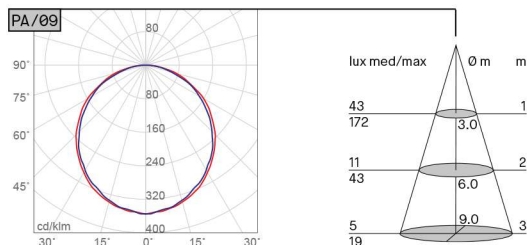

Accessori disponibili su richiesta - Accessories available upon request

Code	Descrizione	Description
KIT/PA09	Kit tappi (4pz)	Kit end caps (4 pcs)
DIF.B/STRIP/3E/S	Diffusore opale L.2m	Opal diffuser L.2m
DIFF/10M/S	Diffusore opale in bobina L.10m	Opal diffuser roll L.10m
DIFF/5M/S	Diffusore opale in bobina L.5m	Opal diffuser roll L.5m

PROFILO TRIMLESS / TRIMLESS PROFILE PA10



35 x L+5 mm

Profilo in alluminio lineare per striscia LED, lunghezza 2000mm. Installazione da incasso trimless in controsoffitti di cartongesso da 12,5mm. Alluminio anodizzato. Installazione con alette laterali tramite viti. Diffusore opale in PC.

Linear aluminium profile for LED strip, length 2000mm. Trimless recessed-mounted installation on plasterboard ceiling of 12,5mm. Anodized aluminium. Installation through lateral edges with screws. Opal PC diffuser

Code	Diffuser		Code (1cm)	
PA/10/S	opale - opal	PC	PA/10/S/1	Taglio su misura - Customized length

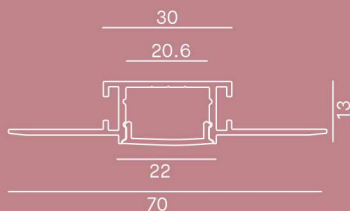
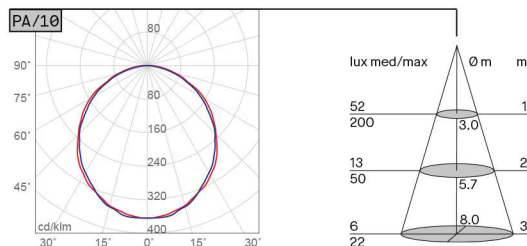

Accessori disponibili su richiesta - Accessories available upon request

Code	Descrizione	Description
KIT/PA10	Kit tappi (4pz.)	Kit end caps (4 pcs)
DIFF/PA10/S	Diffusore opale L.2m	Opal diffuser L.2m

PROFILO CON SCHERMO ARRETRATO / PROFILE WITH RECESSED DIFFUSER PA11



Profilo in alluminio lineare per striscia LED con diffusore arretrato, lunghezza 2000mm. Installazione a superficie. Possibilità di installazione a sospensione tramite accessori da ordinare separatamente. Alluminio verniciato bianco RAL9003 o nero RAL9005. Diffusore in PC opale. Accessori inclusi: tappi (4 pz) e clip di fissaggio (4 pz)

Linear aluminium profile for LED strip with recessed diffuser, length 2000mm. Surface-mounted installation. Possibility to realise a suspended installation with separate accessories. White-painted aluminium RAL9003, black-painted aluminium RAL9005. Opal PC diffuser. Included accessories: end caps (4pcs) and fixing clips (4pcs).

Code	Diffuser	Code (1cm)
PA/11/S	opale - opal	PC PA/11/S/1 Taglio su misura - Customized length
PA/11/S/B	opale - opal	PC PA/11/S/B/1 Taglio su misura - Customized length

Accessori disponibili su richiesta - Accessories available upon request

Code	Descrizione	Description
KIT/PA11	Kit tappi(4pz) e clip di fissaggio(4pz)	Kit fixing clips(4pcs), end caps (4pcs)
KIT/PA11/B	Kit tappi(4pz) e clip di fissaggio(4pz)	Kit fixing clips(4pcs), end caps (4pcs)
DIF.B/STRIP/3E/S	Diffusore opale L.2m	Opal diffuser L.2m
DIFF/10M/S	Diffusore opale in bobina L.10m	Opal diffuser roll L.10m
DIFF/5M/S	Diffusore opale in bobina L.5m	Opal diffuser roll L.5m
KIT/SOSP/PA	Kit sospensione L.2m(2pz)	Suspension kit L.2m(2pz)

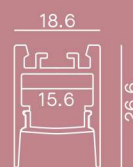

PROFILO CON SCHERMO ARRETRATO / PROFILE WITH RECESSED DIFFUSER PA12



Profilo in alluminio lineare per striscia LED con diffusore arretrato, lunghezza 2000mm. Installazione a superficie. Possibilità di installazione a sospensione con accessori da ordinare separatamente. Alluminio verniciato bianco RAL9003 o nero RAL9005. Diffusore in PC opale. Accessori inclusi: Kit tappi (4 pz) e clip di fissaggio (4 pz, 2 corte e 2 lunghe) e nastro nero (2pz) per evitare il filtraggio di luce.

Linear aluminium profile for LED strip with recessed diffuser, length 2000mm. Surface-mounted installation. Possibility to realise a suspended installation with separate accessories. White-painted aluminium RAL9003, black-painted aluminium RAL9005. Opal PC diffuser. Included accessories: end caps (4pcs), fixing clips (4pcs, 2 short and 2 long), black tape (2pcs) to avoid joint light leak.

Code	Diffuser	Code (1cm)
PA/12/S	opale - opal	PC PA/12/S/1 Taglio su misura - Customized length
PA/12/S/B	opale - opal	PC PA/12/S/B/1 Taglio su misura - Customized length

Accessori disponibili su richiesta - Accessories available upon request

Code	Descrizione	Description
KIT/PA12	Kit tappi(4pz) e clip di fissaggio(4pz)	Kit fixing clips(4pcs), end caps (4pcs)
KIT/PA12/B	Kit tappi(4pz) e clip di fissaggio(4pz)	Kit fixing clips(4pcs), end caps (4pcs)
DIFF/PA12/S	Diffusore opale L.2m	Opal diffuser L.2m
KIT/SOSP/PA	Kit sospensione L.2000mm(2pz)	Suspension kit L.2000mm(2pz)

Clip lunga per fila continua
Long clip suitable
for continuous line

Kit sospensione / Suspension kit

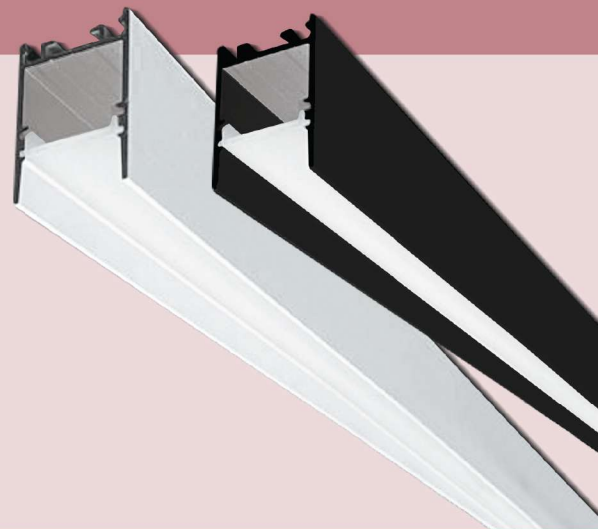
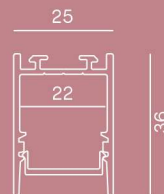
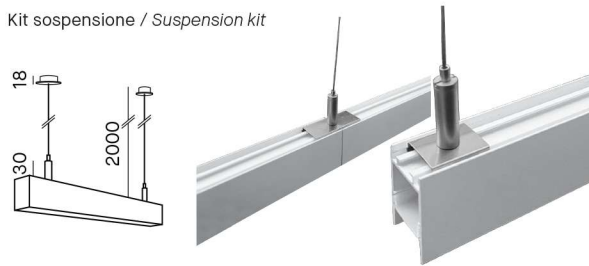

Head Office

Nobile Italia S.p.A.

Viale Alexandre Gustave Eiffel, 100

Isola P 21-24 - 00148 Roma, Italia

Tel: +39 06 65002524 r.a.

info@nobile.it

Export Department

Nobile Italia S.p.A.

Via Laboratori Autobianchi, 1

20832 Desio (MB), Italia

Tel: +39 0362 1790030

export.dpt@nobile.it

